

Temposonics®

Magnetostrictive, Absolute, Non-contact
Linear-Position Sensors



R-Series Models RP and RH
Analog Outputs (Voltage/Current)

Document Part Number
550992 Revision E

Data Sheet



Model RP Profile-style position sensor

Model RH Rod-style position sensor

FEATURES

- Linear, Absolute Measurement
- LEDs For Sensor Diagnostics
- Non-Contact Sensing Technology
- Non-Linearity Less Than 0.01%
- Repeatability Within 0.001%
- Direct Analog Outputs (Voltage or Current)
- Single or Dual Channel Outputs (Position + Speed)

BENEFITS

- Rugged Industrial Sensor
- Dual Magnet Position Measurement
- 100% Field Adjustable Null And Span Setpoints

APPLICATIONS

- Continuous Operation In Harsh Industrial Conditions
- High Pressure Conditions
- For Accurate, Dual-Magnet Position Measurement

TYPICAL INDUSTRIES

- Fluid Power
- Factory Automation
- Material Handling and Packaging
- Woodworking, Metalworking and Assembly Tools
- Plastic Injection and Blow Molding

Time-based Magnetostrictive position sensing principle

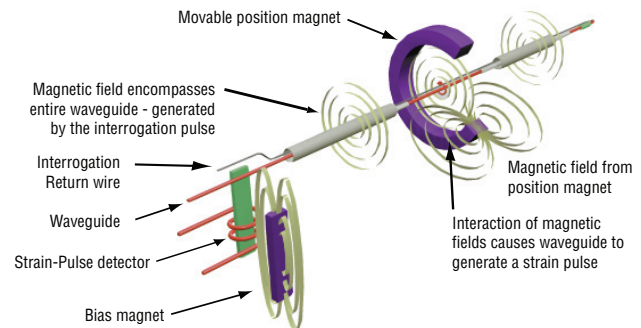

Benefits of Magnetostriction

Temposonics linear-position sensors use the time-based magnetostrictive position sensing principle developed by MTS. Within the sensing element, a sonic-strain pulse is induced in a specially designed magnetostrictive waveguide by the momentary interaction of two magnetic fields. One field comes from a moveable permanent magnet that passes along the outside of the sensor. The other field comes from an "interrogation" current pulse applied along the waveguide. The resulting strain pulse travels at sonic speed along the waveguide and is detected at the head of the sensing element.

The position of the magnet is determined with high precision and speed by accurately measuring the elapsed time between the application of the interrogation pulse and the arrival of the resulting strain pulse with a high-speed counter. The elapsed time measurement is directly proportional to the position of the permanent magnet and is an absolute value. Therefore, the sensor's output signal corresponds to absolute position, instead of incremental, and never requires recalibration or re-homing after a power loss. Absolute, non-contact sensing eliminates wear, and guarantees the best durability and output repeatability.

Sold & Serviced By:



Toll Free Phone (877) SERV098
Toll Free Fax (877) SERV099
www.electromate.com
sales@electromate.com

Product overview

R-Series model RH and RP sensors are extremely robust and are ideal for continuous operation under harsh industrial conditions.

MTS offers two standard sensor housings, rod and profile extrusion. The rod housing is capable of withstanding high pressures such as those found in hydraulic cylinders. The profile extrusion housing provides convenient mounting options and captive sliding magnets which utilize slide bearings of special material that reduce friction, and help mitigate dirt build up.

The sensor head contains the active signal conditioning and a complete integrated electronics interface. Double shielding is used to ensure EMI protection for unsurpassed reliability and operating safety.

Product specifications

Parameters	Specifications
OUTPUT	
Measured output variables:	Position + speed (magnitude) or velocity (with direction) for single or dual magnets
Resolution:	Position measurement: 16 bit; 0.0015% (minimum 1 µm) Speed measurement: 0.1 mm/s
Non-linearity:	< ± 0.01% full stroke (minimum ± 50 µm)
Repeatability:	< ± 0.001% full stroke (minimum ± 2.5 µm)
Hysteresis:	< 4 µm
Analog Outputs:	Voltage: 0 to 10, 10 to 0, -10 to +10, +10 to -10 Vdc (minimum controller load >5k ohms) Current: 4(0) to 20 mA, 20 to 4(0) mA (minimum/maximum load 0/500 ohms)
Stroke lengths:	Range (Profile style): 25 to 5080 mm (1 to 200 in.) Range (Rod style): 25 to 7620 mm (2 to 300 in.) Range (Flexible 1tyle): 255 to 10,060 mm (10 to 396 in.) <i>(Contact factory for longer stroke lengths)</i> Update times: 0.5 ms up to 1200 mm, 1.0 ms up to 2400 mm, 2.0 ms up to 4800 mm, 5.0 ms up to 7620 mm stroke length
Speed measurement:	Range: 0.025 - 10 m/s (1.0 - 400.0 in./s) Deviation: <0.5% Resolution: 0.1 mm/s (0.004 in./s) Update time: Refer to update times in 'Position measurement' above

Parameters	Specifications
ELECTRONICS	
Operating voltage:	+24 Vdc nominal: -15% or +20% Polarity protection: up to -30 Vdc Over voltage protection: up to 36 Vdc Current drain: 100 mA typical Dielectric withstand voltage: 500 Vdc (DC ground to machine ground)
Setpoints:	Setpoint adjustment (Null/Span): 100% of electrical stroke length. 25 mm (0.98 in.) min. distance between setpoints. For dual-magnet outputs: 76 mm (3 in.) min. distance between magnets
ENVIRONMENTAL	
Operating conditions:	Operating temperature: -40 °C (-40 °F) to +75 °C (+167 °F) Relative humidity: 90% no condensation Temperature coefficient: < 30 ppm/ °C
EMC test:	Emissions: IEC/EN 50081-1 Immunity: IEC/EN 50082-2 IEC/EN 61000-4-2/3/4/6, level 3/4 criterion A, CE qualified
Shock rating:	100 g (single hit)/ IEC standard 68-2-27 (survivability)
Vibration rating:	15 g (30 g with HVR option)/10 to 2000 Hz, IEC standard 68-2-6 (operational)
Wiring	
Connection type:	6-pin male D60 (M16) connector or integral cable
PROFILE STYLE SENSOR (MODEL RP)	
Electronic head:	Aluminum housing with diagnostic LED display (LEDs located beside connector/cable exit)
Sealing:	IP 65
Sensor extrusion:	Aluminum (Temposonics profile style)
Mounting:	Any orientation. Adjustable mounting feet or T-slot nut (M5 threads) in bottom groove
Magnet types:	Captive-sliding magnet or open-ring magnet
ROD STYLE SENSOR (MODEL RH)	
Electronic head:	Aluminum housing with diagnostic LED display (LEDs located beside connector/cable exit)
Sealing:	IP 67 or IP 68 for integral cable models
Sensor rod:	304L stainless steel
Operating pressure:	350 bar static, 690 bar peak (5000 psi static, 10,000 psi peak)
Mounting:	Any orientation. Threaded flange M18 x 1.5 or 3/4 - 16 UNF-3A
Typical mounting torque:	45 N-m (33 ft. - lbs.)
Magnet types:	Ring magnet, open-ring magnet, or magnet float

Output options

R-Series analog sensors provide single or dual-magnet sensor options along with single or dual-channel outputs (see 'Figure 1').

The R-Series analog sensor can be ordered for single-position magnet applications which provide one position output, and/or one velocity output over the active stroke length.

The R-Series sensor can also be ordered for dual-position magnet applications which provide two position outputs, or two velocity outputs, or one of each.

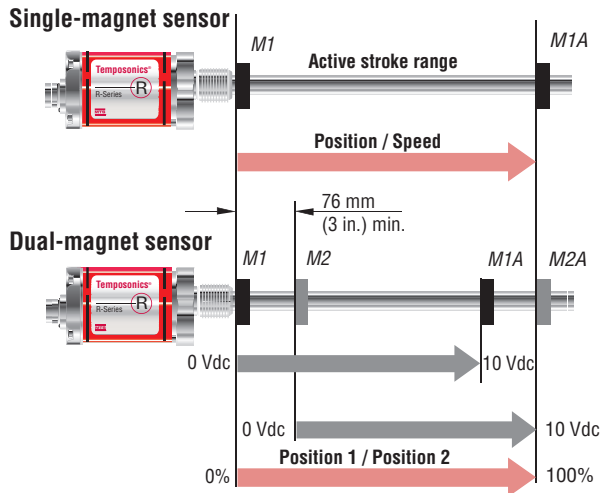

Figure 1. Single and dual-magnet output diagram

When using dual magnets, the minimum allowed distance between the magnets is 76 mm (3 in.) to maintain proper sensor output.

Enhanced monitoring and diagnostics

SENSOR STATUS AND DIAGNOSTIC DISPLAY

Diagnostic LEDs (green/red), located beside the connector or cable exit (see 'Figure 2'), provide basic visual monitoring for normal sensor operation and troubleshooting. Diagnostic display LEDs indicate four modes described in 'Table 1'.



Figure 2. R-Series sensor diagnostic LEDs

Green	Red	Operation status/mode
ON	OFF	Normal function (operation mode)
ON	Flashing	Magnet out of setup range
ON	ON	Magnet not detected or wrong quantity of magnets
Flashing	ON	Programming mode

Table 1. Diagnostic LED codes

Advanced communication and programmability

SENSOR FIELD PROGRAMMING

Temposonics R-Series Analog sensors are pre-configured at the factory by model number designation. For many applications, normal sensor installation and operation does not require additional adjustment. If however, sensor parameter changes are required in the field, the 'R-Series Analog PC Programming Kit, part no. 253309-1' (see 'Figure 3') can be used to easily program the sensor electronically without opening the sensor's housing.

Field programming to adjust the output values is available for any setting needed, within the selected output range. Each sensor's output range is selected from the available options when ordering a particular sensor model number. There are six different manufacturing build types available, three single channel and three dual channel outputs in various ranges as described below:

Single-channel output for either position or speed:

- Voltage output between 0 and +10 volts
- Voltage output between -10 and +10 volts
- Current output between 0 (or 4) and 20 mA

Dual-channel outputs for position and/or speed:

- Voltage outputs between 0 and +10 volts
- Voltage outputs between -10 and +10 volts
- Current outputs between 0 (or 4) and 20 mA

Field Programming Notes:

Field programming allows for numerous custom sensor configurations, however, please note that field programming can not be used to change the R-Series Analog sensor from one manufacturing build type to another.

Field programming (output voltages):

1. Sensor models ordered with *one output channel* can not be reprogrammed in the field to provide a second output channel.
2. Sensor models ordered with *positive only output voltages* can not be reprogrammed in the field to include negative output voltages.
3. Sensor models ordered with *both positive and negative output voltages* can be reprogrammed in the field for positive only voltages, or negative only voltages. However, resolution is then reduced.



Figure 3. R-Series Analog PC Programming Kit, Part no. 253309-1 (For single or dual magnet sensor applications)

Advanced communication and programmability

SENSOR FIELD PROGRAMMING

R-Series Analog PC Programming Kit (Part no.: 253309-1) includes the following components:

- Wall adapter style power supply (24 Vdc output)
- USB Serial converter box with USB cable to connect to PC
- Two connection cables:
 - Cable with connector if sensor is ordered with the D60 integral connector option.
 - Cable with quick connects if sensor is ordered with the integral cable option.
- R-Series Analog PC Setup software, on CD-ROM (for Windows XP or higher)

The R-Series Analog PC Setup software user-friendly interface (see 'Figure 4') enables the operator to take advantage of customizing the following settings:

- Magnet positions and sensor output values for Setpoint 1 (Null) and Setpoint 2 (Span) for single or dual magnets. For additional information about setpoints, refer to section 'R-Series analog handheld programmer for single-magnet sensors'.
- Output range settings for speed, or for speed with direction.
- Assign position or velocity output functions for the single or dual magnets, and for the one or two output channels. Output function assignments are limited to the manufacturing build type of the sensor.
- Assign error output values when the magnet moves beyond the programmed setpoints.

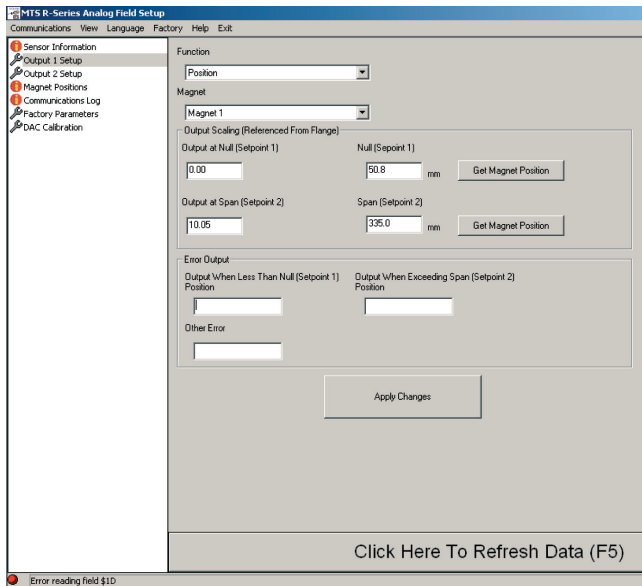

Figure 4. R-Series PC Setup software interface

R-SERIES ANALOG HANDHELD PROGRAMMER FOR SINGLE MAGNET SENSOR APPLICATIONS

The R-Series Analog Handheld Programmer (see Figure 5) can be used to program the magnet positions for the start of output, (0% = 0 Vdc, -10 Vdc, 4 mA, or 0 mA), and the end of output, (100% = 10 Vdc or 20 mA), for the single magnet version of the R-Series analog sensor.



Figure 5. R-Series Analog Handheld Programmer, Part no.: 253124

Standard factory settings place the setpoint 1 'Null' and setpoint 2 'Span' at the limits of the sensor's active stroke range. For example, a sensor ordered with 4 - 20 mA output will be factory set for 4 mA output at the bottom limit of the stroke range at the 'Null' position. Likewise, the 20 mA output will be factory set at the top limit of the stroke range at the 'Span' position.

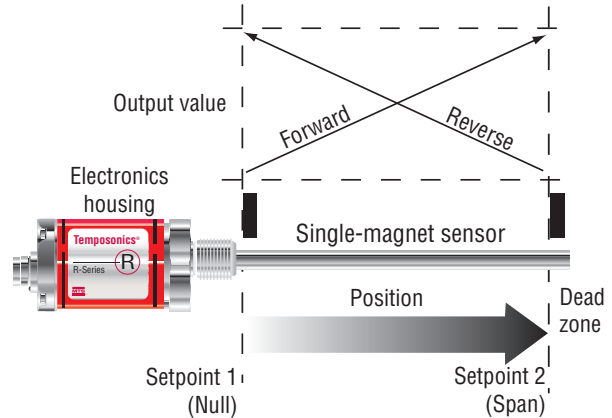

Figure 6. Standard factory settings

Setpoint 1 and setpoint 2 can be re-positioned for the actual measuring length needed anywhere within the active stroke range.

Note:
The minimum distance allowed between setpoint 1 and setpoint 2 is 25 mm (0.98 in.).

These adjustments are easily performed, even when the sensor is not directly accessible, by connecting the analog handheld programmer to the sensor's integral cable or extension cable.

When programming new setpoints, the R-Series Analog Handheld Programmer adjusts the sensor output values to either 0% or 100% at the two selected magnet positions. To program other setpoint output values, use the 'R-Series Analog PC Programming Kit' (Part no.: 253309-1).

Note:
The R-Series Analog Handheld Programmer can also be used to change the output direction from forward-acting (e.g. 4 - 20 mA output) to reverse-acting (20 - 4 mA output), as well as, reverse-acting to forward-acting.

Standard magnet selections (Model RP)

SELECTION OF POSITION MAGNETS (ONE MAGNET INCLUDED WITH MODEL RP SENSOR)

A choice of two magnet mounting configurations are available with the profile-style sensor; A 'captive-sliding' magnet, *Styles S or V* or an 'open-ring' magnet, *Style M*. Captive-sliding magnets utilize slide bearings of special material that reduce friction, and if required, help mitigate dirt build up. The slide bearings are designed to operate dry, requiring no external lubrication or maintenance.

The *Style M* 'open-ring' magnet mounts on the moving machine part and travels just above the sensor's profile extrusion. The open-ring magnet requires a minimum distance away from ferrous metals to allow proper sensor output. It must be mounted using non-ferrous screws and a non-ferrous support bracket, or utilize a non-ferrous spacer of at least 5 mm (0.2 in.) thickness.

POSITION MAGNET SELECTIONS (One Magnet included with each Model RP sensor)

(Drawing dimensions are for reference only)

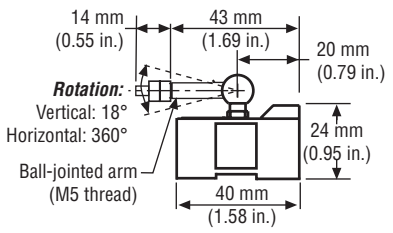
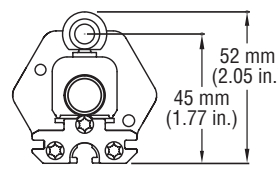
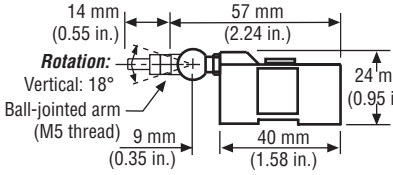
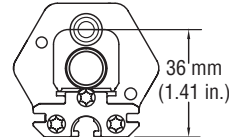
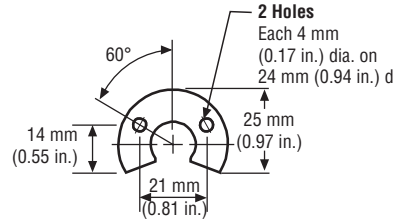
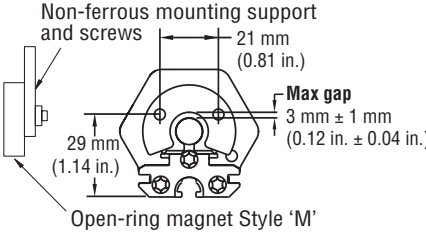
Magnet dimensions	Mounted magnet dimensions	Description	Part number
		<p>Captive-sliding magnet, Style S For Model RP profile-style sensor</p>	<p>252182</p>
		<p>Captive-sliding magnet, Style V For Model RP profile-style sensor</p>	<p>252184</p>
		<p>Open-ring magnet, Style M I.D.: 13.5 mm (0.53 in.) O.D.: 33 mm (1.3 in.) Thickness: 8 mm (0.31 in.) Operating temperature: - 40 °C to +100 °C</p>	<p>251416-2</p>





Sensor mounting

MODEL RP PROFILE-STYLE SENSOR MOUNTING *Flexible installation in any position!*

Temposonics model RP profile-style sensors offer two basic mounting methods; side grooves for use with mounting feet or a bottom groove that accepts special T-Slot nuts. Both the mounting feet and T-Slot nuts can be positioned along the sensor extrusion to best secure the sensor for each particular application.

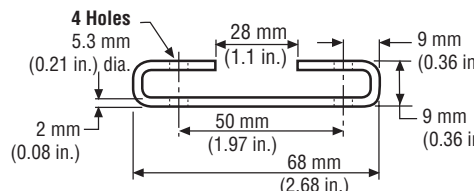
Notes:

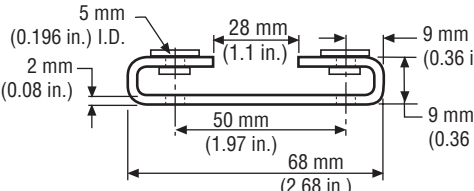
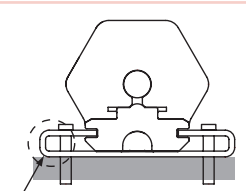
1. Model RP sensors include two mounting feet, (part no. 400802) for sensors stroke lengths up to 1250 mm (50 in.)
2. One additional mounting foot is included for stroke lengths over 1250 mm (50 in.) and for each additional 500 mm (20 in.), thereafter.
3. MTS recommends using 10-32 cap screws (customer supplied) at a maximum torque of 44 in. lbs. when fastening mounting feet.

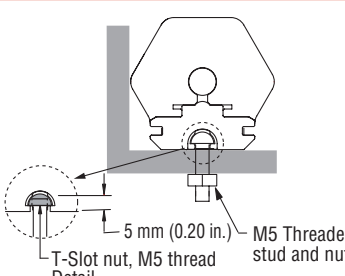
Profile-Style sensor mounting and installation reference	Mounting method	Part number
  <p>(Width = 14.5 mm (0.57 in.))</p>	<p>Mounting feet, standard (304 SS) Profile-style sensor mounting for sensor model RP</p>	<p>400802</p>
  <p>(Width = 14.5 mm (0.57 in.))</p>	<p>Mounting feet, Insulated (304 SS) Profile-style sensor mounting for sensor model RP. Nylon washers and cloth tape on the bottom provide electrical isolation.</p>	<p>252004</p>
<p>10-32 Cap screws recommended (customer supplied)</p>  <p>Mounting foot and screws</p>	<p>Mounting feet and screws Profile-style sensor foot installation</p>	<p>See Mounting Foot part numbers: 400802 and 252004</p>
  <p>T-Slot nut, M5 thread Detail</p> <p>5 mm (0.20 in.) M5 Threaded stud and nut</p>	<p>T-Slot nut Nut for mounting model RP sensor. M5 thread (optional, ordered separately)</p>	<p>401602</p>

Model RH rod-style sensor dimension references

The Temposonics R-Series rod-style sensor (Model RH) offers modular construction, flexible mounting configurations, and easy installation. The Model RH sensor is designed for mounting in applications where high pressure conditions exist, (5000 psi continuous, 10,000 psi spike), such as inside hydraulic cylinders. The Model RH sensor (see Figure 10) may also be mounted externally in many applications.

Stroke-dependent Dead Zones:	
Stroke length:	Dead zone:
25 mm (1 in.) - 5000 mm (197 in.)	63.5 mm (2.5 in.)
5005 mm (197.1 in.) - 7620 mm (300 in.)	66 mm (2.6 in.)

MODEL RH, ROD-STYLE SENSOR WITH RING MAGNET (MAGNET ORDERED SEPARATELY)

Drawing is for reference only, contact applications engineering for tolerance specific information.

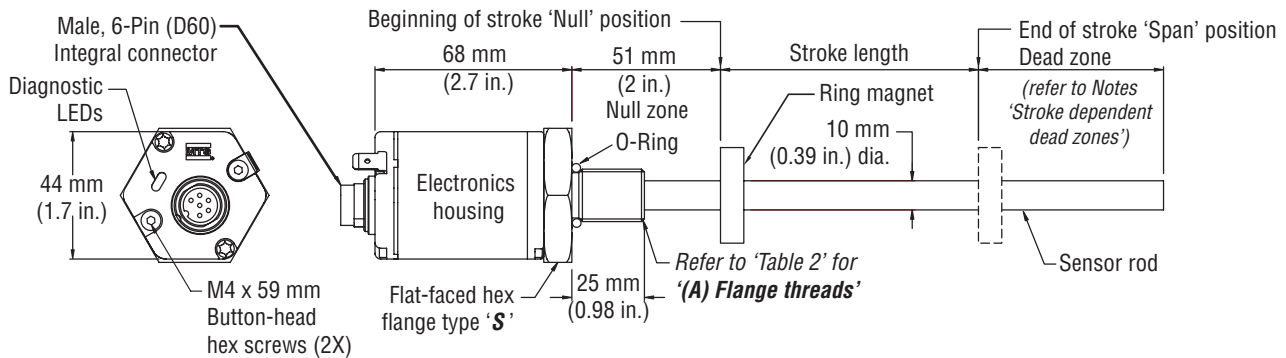

Figure 10. Model RH Rod-style sensor dimension reference (shown with the **D60** integral connection)

MODEL RH, ROD-STYLE SENSOR WITH 6-PIN DIN MATING CABLE CONNECTOR (MAGNET ORDERED SEPARATELY)

Drawing is for reference only, contact applications engineering for tolerance specific information.

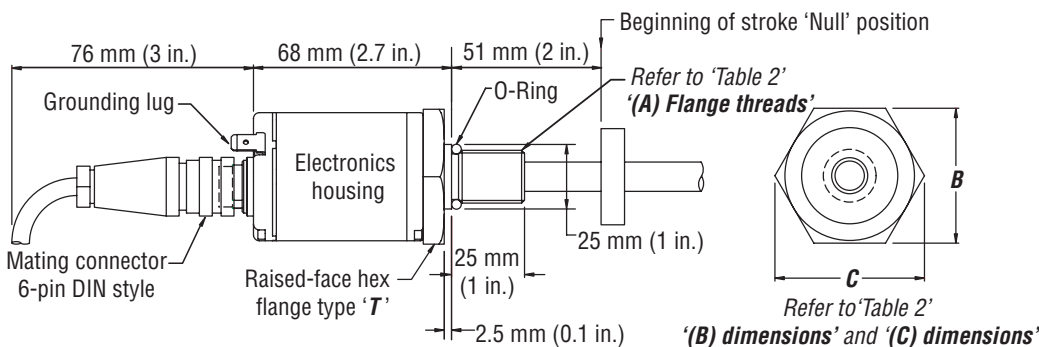

Figure 11. Model RH Rod-style sensor dimension reference (shown with mating cable connector)







Housing style Flange type	Description	(A) Flange threads	(B) Dimensions	(C) Dimensions
T	US customary threads with raised-face flange	3/4" - 16 UNF-3A	1.75 in.	2 in.
S	US customary threads with flat-faced flange	3/4" - 16 UNF-3A	1.75 in.	2 in.
M	Metric threads with flat-faced flange	M18 x 1.5	46 mm	53 mm

Table 2. Model RH Rod-style sensor housing style and flange type references

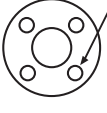
Standard magnet selections (Model RH)

Magnets must be ordered separately with model RH position sensors. The standard ring magnet (part number 201542-2) is suitable for most applications.

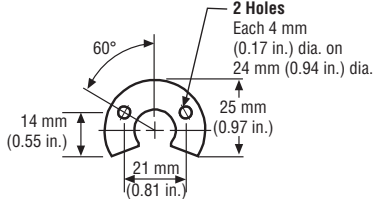
POSITION MAGNET SELECTIONS (Magnet must be ordered separately) (Drawing dimensions are for reference only)

Magnet	Magnet dimensions	Description	Part number
	 4 Holes Each 4.3 mm (0.17 in.) dia. 90° apart on 24 mm (0.94 in.) dia.	Standard ring magnet I.D.: 13.5 mm (0.53 in.) O.D.: 33 mm (1.3 in.) Thickness: 8 mm (0.3 in.) Operating temperature: - 40 °C to +100 °C	201542-2
		Ring magnet I.D.: 13.5 mm (0.53 in.) O.D.: 25.4 mm (1 in.) Thickness: 8 mm (0.3 in.) Operating temperature: - 40 °C to +100 °C	400533
	 2 Holes Each 4 mm (0.17 in.) dia. on 24 mm (0.94 in.) dia. 60° 14 mm (0.55 in.) 25 mm (0.97 in.) 21 mm (0.81 in.)	Open-ring magnet, Style M I.D.: 13.5 mm (0.53 in.) O.D.: 33 mm (1.3 in.) Thickness: 8 mm (0.3 in.) Operating temperature: - 40 °C to +100 °C	251416-2
	 4 Holes Each 4.3 mm (0.17 in.) dia. 90° apart on 24 mm (0.94 in.) dia.	Magnet spacer (Non-ferrous, use with ring magnet part no.: 201542-2) I.D.: 14 mm (0.56 in.) O.D.: 32 mm (1.25 in.) Thickness: 3.2 mm (0.125 in.)	400633

MAGNET FLOAT SELECTION (Drawing dimensions are for reference only)

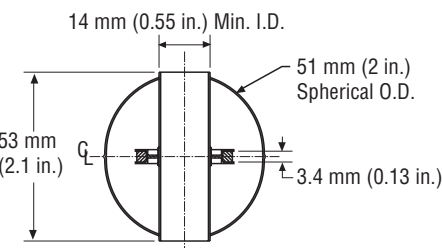
	 14 mm (0.55 in.) Min. I.D. 51 mm (2 in.) Spherical O.D. 53 mm (2.1 in.) 3.4 mm (0.13 in.)	Magnet float (Level sensing applications) Specific gravity: 0.70 maximum Pressure: 870 psi maximum (This float is used with the Model RH rod-style sensors for hydraulic fluid or fresh water applications only)	251447
---	--	---	--------

Model RH Rod-Style sensor mounting

MODEL RH SENSOR MOUNTING

The position magnet requires minimum distances away from ferrous metals to allow proper sensor output. The minimum distance from the front of the magnet to the cylinder end cap is 15 mm (0.6 in.).

The minimum distance from the back of the magnet to the piston head is 3.2 mm (0.125 in.). The non-ferrous spacer (part no. 400633), provides this minimum distance when used along with the standard ring magnet (part no.: 201542-2).

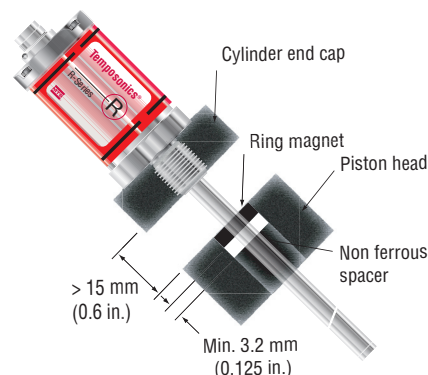

Figure 12. Model RH rod-style mounting

Model RH Rod-Style sensor cylinder installation

When used for direct-stroke measurement in fluid cylinders, the sensor's high pressure, stainless steel rod installs into a bore in the piston head/rod assembly as illustrated. This method guarantees a long-life and trouble-free operation.

The sensor cartridge can be removed from the flange and rod housing while still installed in the cylinder. This procedure allows quick and easy sensor cartridge replacement, without the loss of hydraulic pressure.

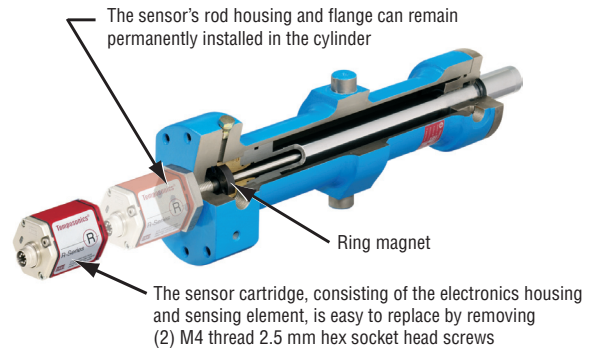

Figure 13. Fluid cylinder installation

Models RP and RH connections and wiring

STANDARD MALE (D60) 6-PIN DIN INTEGRAL CONNECTOR (M16)

Note:

When using the single channel output, (pins 1 and 2), the unused pins for output 2 (pins 3 and 4) should be left floating (unconnected), unless sensor programming is being performed.



Male, 6-pin (D60) integral connector pin-out as viewed from the end of the sensor

Pin Number	Wire Color	Function / Analog outputs
1	Gray	Output 1/ Position 1: 0 to 10, 10 to 0, -10 to +10, +10 to -10 Vdc 4 to 20, 20 to 4, 0 to 20, 20 to 0 mA <i>(Required for programming mode / 0% setting)</i>
2	Pink	Return for pin 1
3	Yellow	Output 2/ Position 2 or Speed: 0 to 10, 10 to 0, -10 to +10, +10 to -10 Vdc 4 to 20, 20 to 4, 0 to 20, 20 to 0 mA <i>(Required for programming mode / 100% setting)</i>
4	Green	Return for pin 3
5	Red or Brown	+24 Vdc (-15/+20%) <i>(Required for programming mode)</i>
6	White	DC ground (for supply) <i>(Required for programming mode)</i>

CABLE CONNECTOR OPTIONS (FIELD INSTALLABLE) 6-PIN DIN (D60) FEMALE

(Drawing dimensions are for reference only)

Connector	Connector dimensions	Description	Part number
		Cable Connector, Female, Straight Exit (Field installable) 6-Pin DIN (D60) Mates with standard male (M16) integral connector	560700
		Cable Connector, Female, 90° Exit (Field installable) 6-Pin DIN (D60) Mates with standard male (M16) integral connector	560778

Sold & Serviced By:



Toll Free Phone (877) SERV098
 Toll Free Fax (877) SERV099
 www.electromate.com
 sales@electromate.com

EXTENSION CABLE WITH CONNECTORS FOR D6, (D60), CONNECTION TYPES

Extension Cable and Connector Assemblies	Description	Connection Type
	Connector, Straight Exit with Standard PVC Jacket Cable <i>(Assembly Includes D6 Connector, Part No.: 560700 and Cable, Part No.:530026)</i>	D6
	Connector, 90° Exit with Standard PVC Jacket Cable <i>(Assembly Includes D6 Connector, Part No.: 560778 and Cable, Part No.:530026)</i>	DA
	Connector, Straight Exit with Black Polyurethane Jacket Cable (for higher resistance to moisture, oil and cold temperatures) <i>(Assembly Includes D6 Connector, Part No.: 560700 and Cable, Part No.:530045)</i>	DJ
	Connector, 90° Exit with Black Polyurethane Jacket Cable (for higher resistance to moisture, oil and cold temperatures) <i>(Assembly Includes D6 Connector, Part No.: 560778 and Cable, Part No.:530045)</i>	DK

Ordering Information

Extension Cable with Connector for a D6 (D60) Connection Type



SENSOR CONNECTION TYPES

- D6** = Female connector, straight exit (part no. 560700), and PVC jacket cable (part no. 530026)
- DA** = Female connector, 90° exit (part no. 560788), and PVC jacket cable (part no. 530026)
- DJ** = Female connector, straight exit (part no. 560700), and black polyurethane jacket cable (part no. 530045)
- DK** = Female connector, 90° exit (part no. 560788), and black polyurethane jacket cable (part no. 530045)

CABLE LENGTHS

For standard length cables up to 100 ft

- 005** = 5 ft
- 015** = 15 ft
- 025** = 25 ft
- 050** = 50 ft
- 100** = 100 ft

For custom length cables over 100 ft

--- = Cable length (maximum cable length is dependent on the output selected; consult MTS Applications Engineering)

CABLE TERMINATION

- P0** = Pigtail cable without connector (2 digit code)
- D6M** = D6 male connector (straight exit). Only available with the **D6** option above.
- D6F** = D6 female connector (straight exit). Only available with the **D6** option above.
- DAF** = D6 female connector (90° exit). Only available with the **DA** option above.

D								1 - 2
								3 - 5
								6 - 8

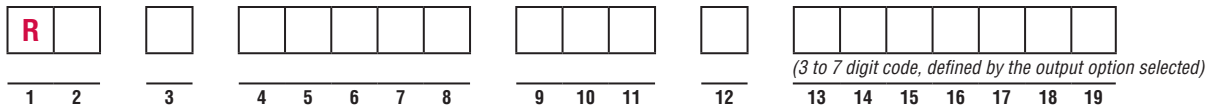

2 Output channels with 2 magnets (3 digit code)

13 - 15

Choose a value described below to encode 3 digits (sensor part number boxes 13-15) refer to 'Setpoint Note'

Output #1 = Magnet #1 position	Output #2 = Magnet #2 position
V02 = 0 to +10 Vdc	0 to +10 Vdc
V12 = +10 to 0 Vdc	+10 to 0 Vdc
V22 = -10 to +10 Vdc	-10 to +10 Vdc
V32 = +10 to -10 Vdc	+10 to -10 Vdc
A02 = 4 to 20 mA	4 to 20 mA
A12 = 20 to 4 mA	20 to 4 mA
A22 = 0 to 20 mA	0 to 20 mA
A32 = 20 to 0 mA	20 to 0 mA

Setpoint Note:
Standard factory settings for the setpoint positions are the same for both magnets, i.e. both magnets have setpoint 1 at the Null position, and setpoint 2 at the Span position. If needed, the setpoint positions for each magnet can be reprogrammed in the field to best fit the application, (see page 4 for more information). For proper sensor output, the minimum allowed distance between magnets is 3 in. (76 mm).

2 Output channels with 1 magnet (7 digit code)

13 - 19

(Choose a maximum speed value described below in Table 3 to encode all 7 digits (sensor part number boxes 13 - 19))

Output #1 = Magnet position	Output #2 = Speed magnitude	
V01 _____ = 0 to +10 Vdc	+10 (towards head)	0 (at rest)
V11 _____ = +10 to 0 Vdc	+10 (towards head)	0 (at rest)
A01 _____ = 4 to 20 mA	20 (towards head)	4 (at rest)
A11 _____ = 20 to 4 mA	20 (towards head)	4 (at rest)
Output #1 = magnet position	Output #2 = Velocity (speed with direction)	
V41 _____ = 0 to +10 Vdc	0 (towards head)	5 (at rest)
V51 _____ = +10 to 0 Vdc	+10 (towards head)	5 (at rest)
V61 _____ = 0 to +10 Vdc	-10 (towards head)	0 (at rest)
V71 _____ = +10 to 0 Vdc	+10 (towards head)	0 (at rest)
V81 _____ = -10 to +10 Vdc	-10 (towards head)	0 (at rest)
V91 _____ = +10 to -10 Vdc	+10 (towards head)	0 (at rest)
A41 _____ = 4 to 20 mA	4 (towards head)	12 (at rest)
A51 _____ = 20 to 4 mA	20 (towards head)	12 (at rest)
Output #1 = Magnet position (forward-acting)	Output #2 = Magnet position (reverse-acting)	
V03 _____ = 0 to +10 Vdc (3 digit code)	+10 to 0 Vdc	+10 (towards tip) Vdc
		+10 (towards tip) Vdc
		20 (towards tip) mA
		20 (towards tip) mA

TABLE 3. FOR SENSOR MODELS WITH SPEED OUTPUT

(Choose a maximum speed value described below to encode the last 4 digits (sensor part number boxes 16-19))

For US customary stroke lengths, encode speed for in./s.

____ = Speed output maximum
Available range for US customary stroke lengths is 1.0 to 400.0 in./s, (0010 ... 4000)
Example:
Maximum speed of 12.0 in./s, and output produced for velocity = [-10(towards head) ... 0(at rest) ... +10(towards tip) Volts]
Encode: **V 6 1 0 1 2 0** or **V 8 1 0 1 2 0**

For metric stroke lengths, encode speed for m/s (range #1) or mm/s (range #2) using the information provided below:

Speed range #1, (0 _ _ _ . _)

0 _ _ _ . _ = Speed output maximum
Speed range #1 for metric stroke lengths is 0.1 to 10.0 m/s, (0001 ... 0100)
Example:
Maximum speed of 5.5 m/s, and output produced for speed = [+10(towards head) ... 0(at rest) ... +10(towards tip) Volts],
Encode: **V 0 1 0 0 5 5**

Speed range #2, (1 _ _ _ _)

1 _ _ _ _ = Speed output maximum.
Speed range #2 for metric stroke lengths is 25 to 90 mm/s, (1025 ... 1090)
Example:
Maximum speed of 50 mm/s, and output produced for velocity = [4(towards head) ... 12(at rest) ... 20(towards tip) mA]
Encode: **A 4 1 1 0 5 0**

Sold & Serviced By:



Toll Free Phone (877) SERV098
Toll Free Fax (877) SERV099
www.electromate.com
sales@electromate.com